

PRODUCT INFORMATION

| VRS KIT LIST | | | |
|--------------|----------------------------|-------|-----|
| AURA SERIES | | KIT # | QTY |
| G3-S10 | CHEST PRESS | 1 | 1 |
| G3-S12 | PECTORAL FLY | 1 | 1 |
| G3-S13 | CONVERGING CHEST PRESS | 1 | 1 |
| G3-S20 | SHOULDER PRESS | 1 | 1 |
| G3-S21 | LATERAL RAISE | 1 | 1 |
| G3-S22 | REAR DELT/FLY | 1 | 1 |
| G3-S23 | CONVERGING SHOULDER PRESS | 1 | 1 |
| G3-S30 | LAT PULLDOWN | 1 | 1 |
| G3-S31 | SEATED ROW | 1 | 1 |
| G3-S33 | DIVERGING LAT PULLDOWN | 1 | 1 |
| G3-S34 | DIVERGING SEATED ROW | 1 | 1 |
| G3-S40 | ARM CURL | 1 | 1 |
| G3-S42 | SEATED DIP | 1 | 1 |
| G3-S45 | TRICEPS EXTENSION | 1 | 1 |
| G3-S50 | ABDOMINAL | 1 | 1 |
| G3-S51 | ABDOMINAL CRUNCH | 1 | 1 |
| G3-S52 | BACK EXTENSION | 1 | 1 |
| G3-S55 | ROTARY TORSO | 1 | 1 |
| G3-S60 | DIP/CHIN ASSIST | 1 | 1 |
| G3-S71 | LEG EXTENSION | 1 | 1 |
| G3-S72 | SEATED LEG CURL | 1 | 1 |
| G3-S73 | PRONE LEG CURL | 1 | 1 |
| G3-S74 | HIP ADDUCTOR | 1 | 1 |
| G3-S75 | HIP ABDUCTOR | 1 | 1 |
| G3-S76 | ROTARY HIP | 1 | 1 |
| G3-S77 | CALF PRESS | 1 | 1 |
| G3-MS24 | ADJUSTABLE PULLEY | 1 | 1 |
| G3-MS51 | LAT PULLDOWN | 1 | 1 |
| G3-MS52 | TRICEPS PRESSDOWN | 1 | 1 |
| G3-MS53 | LOW ROW | 1 | 1 |
| G3-S70 | LEG PRESS | 2 | 1 |
| G3-MSFT | FUNCTIONAL TRAINER 300/400 | 2 | 2 |
| GO SERIES | | KIT # | QTY |
| GO-S13 | CHEST PRESS | 7 | 1 |
| GO-S23 | SHOULDER PRESS | 7 | 1 |
| GO-S33 | LAT PULLDOWN | 7 | 1 |
| GO-S34 | SEATED ROW | 7 | 1 |
| GO-S40 | BICEP CURL | 7 | 1 |
| GO-S42 | SEATED TRICEPS PRESS | 7 | 1 |
| GO-S53 | ABDOMINAL | 7 | 1 |
| GO-S70 | LEG PRESS | 7 | 1 |
| GO-S71 | LEG EXTENSION | 7 | 1 |
| GO-S72 | SEATED LEG CURL | 7 | 1 |
| VERSA SERIES | | KIT # | QTY |
| VS-S13H/P | CHEST PRESS | 3 | 1 |
| VS-S23H/P | SHOULDER PRESS | 3 | 1 |
| VS-S34H/P | SEATED ROW | 3 | 1 |
| VS-S42H/P | SEATED TRICEPS PRESS | 3 | 1 |
| VS-S52H/P | BACK EXTENSION | 3 | 1 |
| VS-S53H/P | ABDOMINAL | 3 | 1 |
| VS-S71H/P | LEG EXTENSION | 3 | 1 |
| VS-S74H/P | HIP ABDUCTOR/ADDUCTOR | 3 | 1 |

| VS-S131H/P | MULTI-PRESS | 3 | 1 |
|-------------------|----------------------------------|-------|-----|
| VS-S331H/P | LAT PULLDOWN/SEATED ROW | 3 | 1 |
| VS-S531H/P | ABDOMINAL/BACK EXTENSION | 3 | 1 |
| VS-S711H/P | LEG EXTENSION/SEATED LEG CURL | 3 | 1 |
| VS-S33H/P | LAT PULLDOWN | 4 | 1 |
| VS-S70 | LEG PRESS | 4 | 1 |
| VS-S70H/P | LEG PRESS | 4 | 1 |
| VS-S13 | CHEST PRESS | 5 | 1 |
| VS-S22 | PEC FLY/REAR DELT | 5 | 1 |
| VS-S22H/P | PEC FLY/REAR DELT | 5 | 1 |
| VS-S23 | SHOULDER PRESS | 5 | 1 |
| VS-S33 | LAT PULLDOWN | 5 | 1 |
| VS-S34 | SEATED ROW | 5 | 1 |
| VS-S40 | BICEP CURL | 5 | 1 |
| VS-S40H/P | BICEP CURL | 5 | 1 |
| VS-S42 | SEATED TRICEPS PRESS | 5 | 1 |
| VS-S52 | BACK EXTENSION | 5 | 1 |
| VS-S53 | ABDOMINAL | 5 | 1 |
| VS-S71 | LEG EXTENSION | 5 | 1 |
| VS-S72 | SEATED LEG CURL | 5 | 1 |
| VS-S72H/P | SEATED LEG CURL | 5 | 1 |
| VS-S74 | HIP ABDUCTOR/ADDUCTOR | 5 | 1 |
| VS-S78 | GLUTE | 5 | 1 |
| VS-S78H/P | GLUTE | 5 | 1 |
| VS-S131 | MULTI PRESS | 5 | 1 |
| VS-S331 | LAT PULLDOWN/SEATED ROW | 5 | 1 |
| VS-S401 | BICEP/TRICEP | 5 | 1 |
| VS-S401H/P | BICEP/TRICEP | 5 | 1 |
| VS-S531 | ABDOMINAL/BACK EXTENSION | 5 | 1 |
| VS-S601 | CHIN/DIP ASSIST | 5 | 1 |
| VS-S601H/P | CHIN/DIP ASSIST | 5 | 1 |
| VS-S711 | LEG EXTENSION/SEATED LEG CURL | 5 | 1 |
| VS-VFT + VS-FTS18 | FUNCTIONAL TRAINER / 18" STORAGE | 6 | 1 |
| VS-VFT + VS-FTS30 | FUNCTIONAL TRAINER / 30" STORAGE | 6 | 1 |
| MEDICAL | | KIT # | QTY |
| MD-S70 | MEDICAL LEG PRESS | 3 | 1 |
| MD-S711 | MEDICAL LEG EXT / LEG CURL | 5 | 1 |
| MD-AP | MEDICAL ADJUSTABLE PULLEY | 7 | 1 |
| ULTRA SERIES | | KIT # | QTY |
| G7-S33 | LAT PULLDOWN | 8 | 1 |
| G7-S34 | SEATED ROW | 10 | 1 |
| G7-S71 | LEG EXTENSION | 10 | 1 |
| G7-S70 | LEG PRESS | 8 | 1 |
| G7-S75 | HIP ABDUCTION | 10 | 1 |
| G7-S77 | CALF EXTENSION | 10 | 1 |
| G7-S23 | SHOULDER PRESS | 10 | 1 |
| G7-S13 | CHEST PRESS | 10 | 1 |
| G7-S72 | SEATED LEG CURL | 10 | 1 |
| G7-S74 | HIP ADDUCTION | 10 | 1 |
| G7-S55 | ROTARY TORSO | 10 | 1 |
| G7-S40 | BICEPS CURL | 10 | 1 |
| G7-S42 | SEATED TRICEPS PRESS | 8 | 1 |
| G7-S41 | ABDOMINAL CRUNCH | 10 | 1 |

| | | | |
|----------|----------------------|----|---|
| G7-S22 | REAR DELT/PEC FLY | 10 | 1 |
| G7-S52 | BACK EXTENSION | 10 | 1 |
| G7-S73 | PRONE LEG CURL | 10 | 1 |
| G7-S78 | GLUTE | 9 | 1 |
| G7-S21 | LATERAL RAISE | 10 | 1 |
| G7-S41 | DEPENDENT ARM CURL | 10 | 1 |
| G7-S45 | TRICEPS EXTENSION | 10 | 1 |
| G7-S79 | HIP THRUST MACHINE | 8 | 1 |
| G7-S33BH | LAT PULLDOWN | 8 | 1 |
| G7-S34BH | SEATED ROW | 10 | 1 |
| G7-S71BH | LEG EXTENSION | 10 | 1 |
| G7-S70BH | LEG PRESS | 8 | 1 |
| G7-S75BH | HIP ABDUCTION | 10 | 1 |
| G7-S77BH | CALF EXTENSION | 10 | 1 |
| G7-S23BH | SHOULDER PRESS | 10 | 1 |
| G7-S13BH | CHEST PRESS | 10 | 1 |
| G7-S72BH | SEATED LEG CURL | 10 | 1 |
| G7-S74BH | HIP ADDUCTION | 10 | 1 |
| G7-S55BH | ROTARY TORSO | 10 | 1 |
| G7-S40BH | BICEPS CURL | 10 | 1 |
| G7-S42BH | SEATED TRICEPS PRESS | 8 | 1 |
| G7-S51BH | ABDOMINAL CRUNCH | 10 | 1 |
| G7-S22BH | REAR DELT/PEC FLY | 10 | 1 |
| G7-S73BH | PRONE LEG CURL | 10 | 1 |
| G7-S78BH | GLUTE | 9 | 1 |
| G7-S21BH | LATERAL RAISE | 10 | 1 |
| G7-S41BH | DEPENDENT ARM CURL | 10 | 1 |
| G7-S45BH | TRICEPS EXTENSION | 10 | 1 |
| G7-S79BH | HIP THRUST MACHINE | 8 | 1 |
| G7-S33B | LAT PULLDOWN | 9 | 1 |
| G7-S34B | SEATED ROW | 9 | 1 |
| G7-S71B | LEG EXTENSION | 9 | 1 |
| G7-S70B | LEG PRESS | 9 | 1 |
| G7-S75B | HIP ABDUCTION | 10 | 1 |
| G7-S77B | CALF EXTENSION | 10 | 1 |
| G7-S23B | SHOULDER PRESS | 9 | 1 |
| G7-S13B | CHEST PRESS | 9 | 1 |
| G7-S72B | SEATED LEG CURL | 10 | 1 |
| G7-S74B | HIP ADDUCTION | 10 | 1 |
| G7-S55B | ROTARY TORSO | 10 | 1 |
| G7-S40B | BICEPS CURL | 10 | 1 |
| G7-S42B | SEATED TRICEPS PRESS | 9 | 1 |
| G7-S51B | ABDOMINAL CRUNCH | 9 | 1 |
| G7-S22B | REAR DELT/PEC FLY | 9 | 1 |
| G7-S52B | BACK EXTENSION | 9 | 1 |
| G7-S73B | PRONE LEG CURL | 10 | 1 |
| G7-S78B | GLUTE | 9 | 1 |
| G7-S21B | LATERAL RAISE | 9 | 1 |
| G7-S41B | DEPENDENT ARM CURL | 10 | 1 |
| G7-S45B | TRICEPS EXTENSION | 10 | 1 |
| G7-S79B | HIP THRUST MACHINE | 9 | 1 |



PRODUCT INFORMATION

| VRS KIT PARTS | | | |
|---------------|------------|--|-----|
| KIT # 1 | | DESCRIPTION | QTY |
| A | AS2112-B01 | Top plate | 1 |
| B | AS2108-B02 | Foam cushion | 6 |
| C | AS2116-Q01 | Base | 1 |
| KIT # 2 | | | |
| A | AS2112-B01 | Top plate | 1 |
| B | AS2108-B02 | Foam cushion | 8 |
| C | AS2116-Q01 | Base | 1 |
| KIT # 3 | | | |
| D | AS2117-AB1 | Top plate | 1 |
| E | AS2117-B04 | Bottom plate | 1 |
| F | AS2118-B01 | Foam cushion | 12 |
| G | GM77-Q05 | Rubber bumper (30mm) | 2 |
| H | AS2117-B05 | Rubber disc | 2 |
| KIT # 4 | | | |
| D | AS2117-AB1 | Top plate | 1 |
| M | AS2127-AB2 | Bottom plate set (with rubber bumpers) | 1 |
| F | AS2118-B01 | Foam cushion | 16 |
| G | GM77-Q05 | Rubber bumper (30mm) | 2 |
| H | AS2117-B05 | Rubber disc | 2 |
| KIT # 5 | | | |
| D | AS2117-AB1 | Top plate | 1 |
| E | AS2117-B04 | Bottom plate | 1 |
| F | AS2118-B01 | Foam cushion | 12 |
| G | GM77-Q05 | Rubber bumper (30mm) | 2 |
| H | AS2117-B05 | Rubber disc | 4 |
| I | GM59-B18 | Rubber bumper (49mm) | 2 |
| KIT # 6 | | | |
| J | AS2119-B01 | Top plate | 4 |
| K | AS2119-B02 | Foam cushion | 12 |
| I | GM59-B18 | Rubber bumper (49mm) | 4 |
| KIT # 7 | | | |
| A | AS2112-B01 | Top plate | 2 |
| B | AS2108-B02 | Foam cushion | 8 |
| G | GM77-Q05 | Rubber bumper (30mm) | 2 |
| I | GM59-B18 | Rubber bumper (49mm) | 2 |
| L | WASHER | Flat washer (20x60L 4mm) | 4 |
| KIT # 8 | | | |
| A | AS2112-B01 | Top plate | 2 |
| B | AS2108-B02 | Foam cushion | 8 |
| M | WASHER | Flat washer (3mm) | 4 |
| KIT # 9 | | | |
| A | AS2112-B01 | Top plate | 2 |
| B | AS2108-B02 | Foam cushion | 6 |
| G | GM77-Q05 | Rubber bumper (30mm) | 2 |
| KIT # 10 | | | |
| A | AS2112-B01 | Top plate | 2 |
| B | AS2108-B02 | Foam cushion | 6 |
| M | WASHER | Flat washer (3mm) | 4 |

| ENVIRONMENTAL CONDITIONS | |
|--------------------------|-------------------------|
| AMBIENT TEMPERATURE | 15°C–27°C (59°F–80.6°F) |
| RELATIVE HUMIDITY | 40%–50% |

NOTE:

- After assembly, cycle the machine to make sure all components are working properly and to verify the VRS foam has settled into position.
- After cycling is complete, the cable/belt length may need to be adjusted



KIT 1

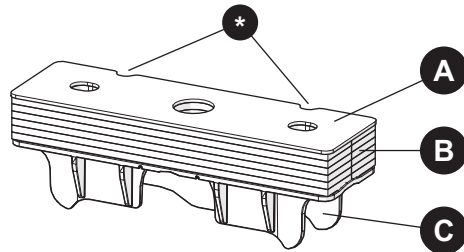

| KIT # 1 | DESCRIPTION | QTY |
|---------|-------------------------|-----|
| A | AS2112-B01 Top plate | 1 |
| B | AS2108-B02 Foam cushion | 6 |
| C | AS2116-Q01 Base | 1 |

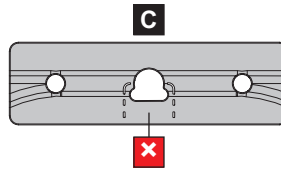

Remove as needed

* NOTE: Two semicircular holes should face the rear.

| PARTS | A | B | C |
|---------|---|---|---|
| G3-S10 | 1 | 6 | 1 |
| G3-S12 | 1 | 6 | 1 |
| G3-S13 | 1 | 6 | 1 |
| G3-S20 | 1 | 6 | 1 |
| G3-S21 | 1 | 6 | 1 |
| G3-S22 | 1 | 6 | 1 |
| G3-S23 | 1 | 6 | 1 |
| G3-S30 | 1 | 6 | 1 |
| G3-S31 | 1 | 6 | 1 |
| G3-S33 | 1 | 6 | 1 |
| G3-S34 | 1 | 6 | 1 |
| G3-S40 | 1 | 6 | 1 |
| G3-S42 | 1 | 6 | 1 |
| G3-S45 | 1 | 6 | 1 |
| G3-S50 | 1 | 6 | 1 |
| G3-S51 | 1 | 6 | 1 |
| G3-S52 | 1 | 6 | 1 |
| G3-S55 | 1 | 6 | 1 |
| G3-S60 | 1 | 6 | 1 |
| G3-S71 | 1 | 6 | 1 |
| G3-S72 | 1 | 6 | 1 |
| G3-S73 | 1 | 6 | 1 |
| G3-S74 | 1 | 6 | 1 |
| G3-S75 | 1 | 6 | 1 |
| G3-S76 | 1 | 6 | 1 |
| G3-S77 | 1 | 6 | 1 |
| G3-MS24 | 1 | 6 | 1 |
| G3-MS51 | 1 | 6 | 1 |
| G3-MS52 | 1 | 6 | 1 |
| G3-MS53 | 1 | 6 | 1 |

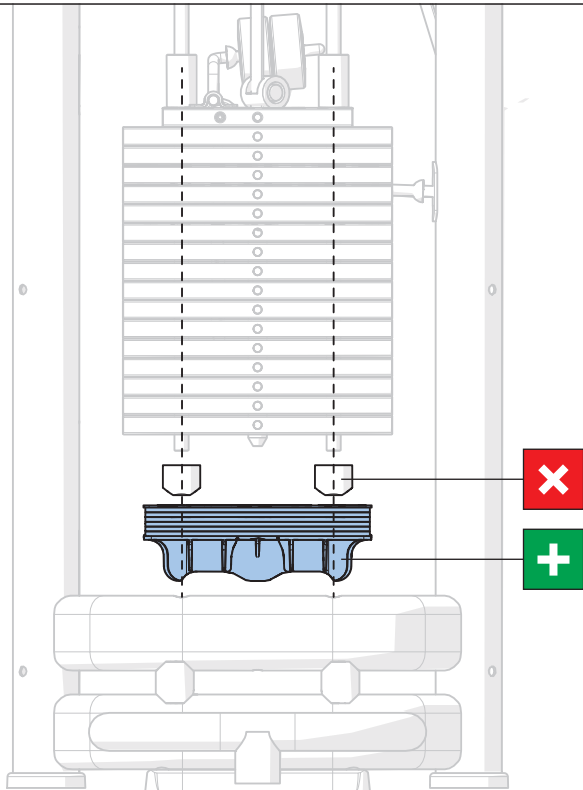

KIT 2

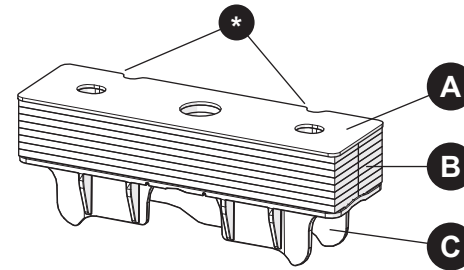

| KIT # 2 | DESCRIPTION | QTY |
|---------|-------------------------|-----|
| A | AS2112-B01 Top plate | 1 |
| B | AS2108-B02 Foam cushion | 8 |
| C | AS2116-Q01 Base | 1 |

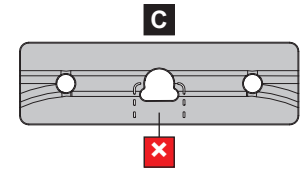

Remove as needed

* NOTE: Two semicircular holes should face the rear.

| PARTS | A | B | C |
|-------------|---|----|---|
| G3-S70 | 1 | 8 | 1 |
| G3-MSFT 400 | 2 | 16 | 2 |
| G3-MSFT 300 | 2 | 16 | 2 |

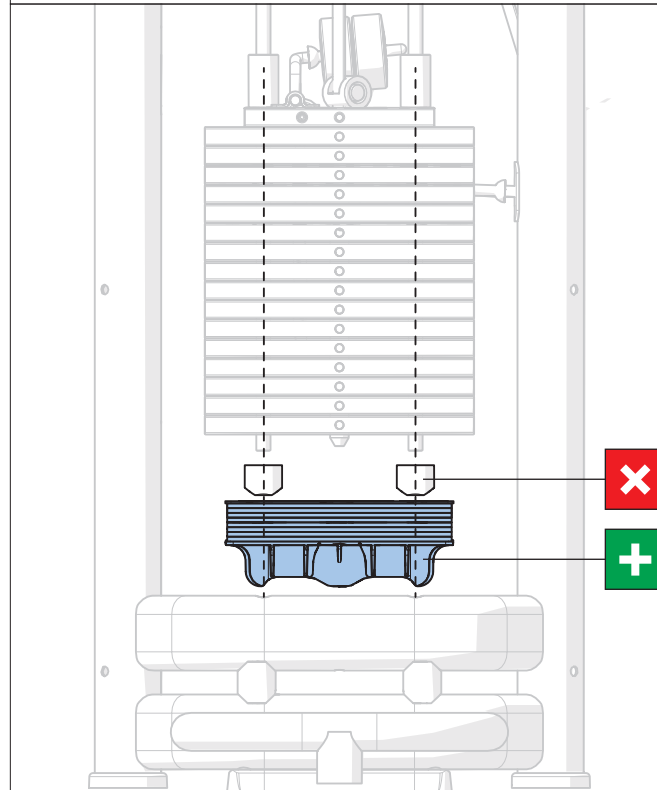



KIT 3

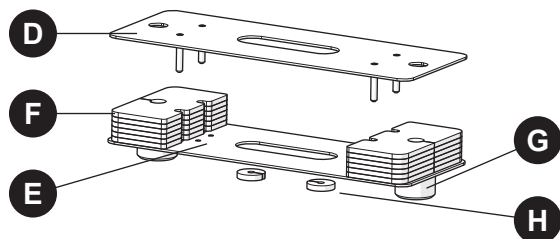

| KIT # 3 | DESCRIPTION | QTY |
|---------|-------------------------------|-----|
| D | AS2117-AB1 Top plate | 1 |
| E | AS2117-B04 Bottom plate | 1 |
| F | AS2118-B01 Foam cushion | 12 |
| G | GM77-Q05 Rubber bumper (30mm) | 2 |
| H | AS2117-B05 Rubber disc | 2 |

NOTE: Part H is not needed for machines without Add-A-Weight

| PARTS | D | E | F | G | H |
|------------|---|---|----|---|---|
| VS-S13H/P | 1 | 1 | 12 | 2 | 2 |
| VS-S23H/P | 1 | 1 | 12 | 2 | 2 |
| VS-S34H/P | 1 | 1 | 12 | 2 | 2 |
| VS-S42H/P | 1 | 1 | 12 | 2 | 2 |
| VS-S52H/P | 1 | 1 | 12 | 2 | 2 |
| VS-S53H/P | 1 | 1 | 12 | 2 | 2 |
| VS-S71H/P | 1 | 1 | 12 | 2 | 2 |
| VS-S74H/P | 1 | 1 | 12 | 2 | 2 |
| VS-S131H/P | 1 | 1 | 12 | 2 | 2 |
| VS-S331H/P | 1 | 1 | 12 | 2 | 2 |
| VS-S531H/P | 1 | 1 | 12 | 2 | 2 |
| VS-S711H/P | 1 | 1 | 12 | 2 | 2 |
| MD-S70 | 1 | 1 | 12 | 2 | 0 |

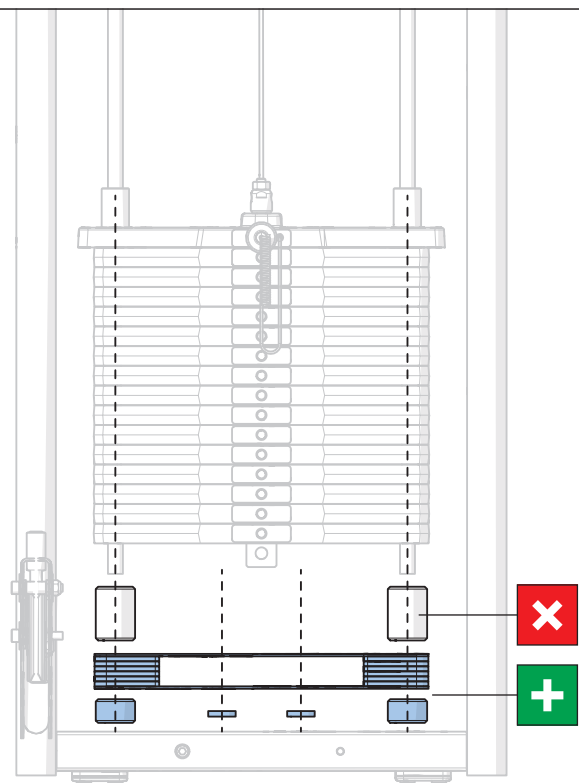

KIT 4

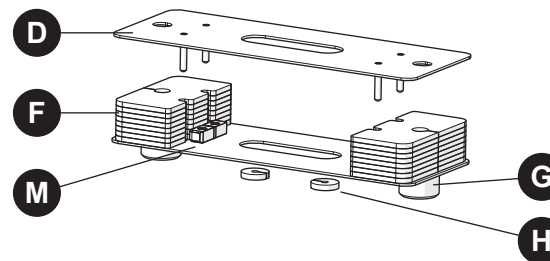

| KIT # 4 | DESCRIPTION | QTY |
|---------|---|-----|
| D | AS2117-AB1 Top plate | 1 |
| M | AS2127-AB2 Bottom plate set (with rubber bumpers) | 1 |
| F | AS2118-B01 Foam cushion | 16 |
| G | GM77-Q05 Rubber bumper (30mm) | 2 |
| H | AS2117-B05 Rubber disc | 2 |

NOTE: Part H is not needed for machines without Add-A-Weight

| PARTS | D | M | F | G | H |
|-----------|---|---|----|---|---|
| VS-S70 | 1 | 1 | 16 | 2 | 2 |
| VS-S70H/P | 1 | 1 | 16 | 2 | 2 |
| VS-S33H/P | 1 | 1 | 16 | 2 | 2 |

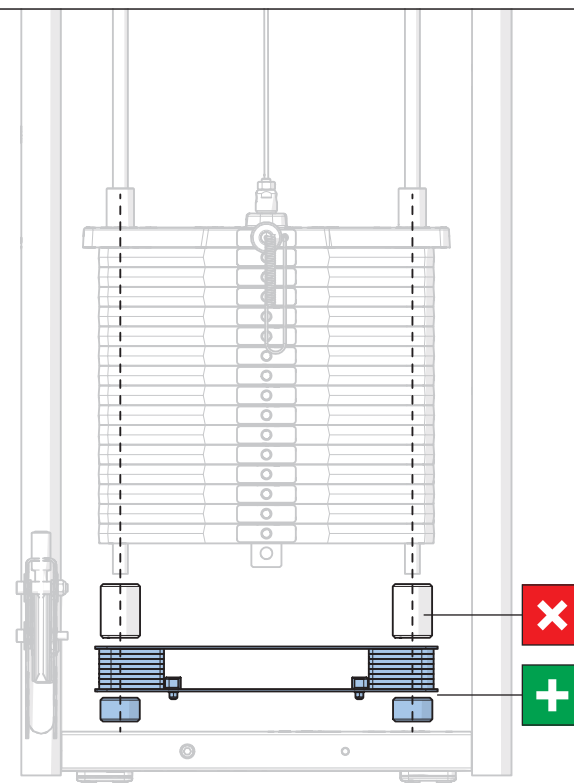



KIT 5

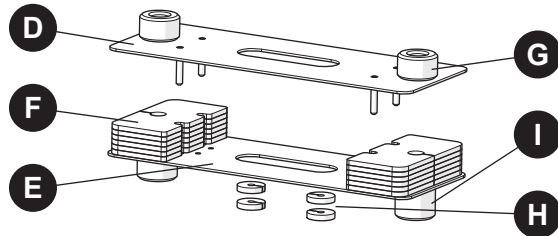

| KIT # 5 | DESCRIPTION | QTY |
|---------|-------------------------------|-----|
| D | AS2117-AB1 Top plate | 1 |
| E | AS2117-B04 Bottom plate | 1 |
| F | AS2118-B01 Foam cushion | 12 |
| G | GM77-Q05 Rubber bumper (30mm) | 2 |
| H | AS2117-B05 Rubber disc | 4 |
| I | GM59-B18 Rubber bumper (49mm) | 2 |

NOTE: Part H is not needed for machines without Add-A-Weight

| PARTS | QTY | | | | | |
|------------|-----|---|----|---|---|---|
| | D | E | F | G | H | I |
| VS-S13 | 1 | 1 | 12 | 0 | 2 | 2 |
| VS-S22 | 1 | 1 | 12 | 2 | 4 | 2 |
| VS-S22H/P | 1 | 1 | 12 | 2 | 2 | 2 |
| VS-S23 | 1 | 1 | 12 | 0 | 2 | 2 |
| VS-S33 | 1 | 1 | 12 | 0 | 0 | 2 |
| VS-S34 | 1 | 1 | 12 | 0 | 2 | 2 |
| VS-S40 | 1 | 1 | 12 | 2 | 4 | 2 |
| VS-S40H/P | 1 | 1 | 12 | 2 | 2 | 2 |
| VS-S42 | 1 | 1 | 12 | 0 | 2 | 2 |
| VS-S52 | 1 | 1 | 12 | 0 | 2 | 2 |
| VS-S53 | 1 | 1 | 12 | 0 | 2 | 2 |
| VS-S71 | 1 | 1 | 12 | 0 | 2 | 2 |
| VS-S72 | 1 | 1 | 12 | 2 | 4 | 2 |
| VS-S72H/P | 1 | 1 | 12 | 2 | 2 | 2 |
| VS-S74 | 1 | 1 | 12 | 0 | 2 | 2 |
| VS-S78 | 1 | 1 | 12 | 2 | 4 | 2 |
| VS-S78H/P | 1 | 1 | 12 | 2 | 4 | 2 |
| VS-S131 | 1 | 1 | 12 | 0 | 2 | 2 |
| VS-S331 | 1 | 1 | 12 | 0 | 2 | 2 |
| VS-S401 | 1 | 1 | 12 | 2 | 4 | 2 |
| VS-S401H/P | 1 | 1 | 12 | 2 | 2 | 2 |
| VS-S531 | 1 | 1 | 12 | 0 | 2 | 2 |
| VS-S601 | 1 | 1 | 12 | 2 | 4 | 2 |
| VS-S601H/P | 1 | 1 | 12 | 2 | 4 | 2 |
| VS-S711 | 1 | 1 | 12 | 0 | 2 | 2 |
| MD-S711 | 1 | 1 | 12 | 0 | 0 | 2 |

KIT 6

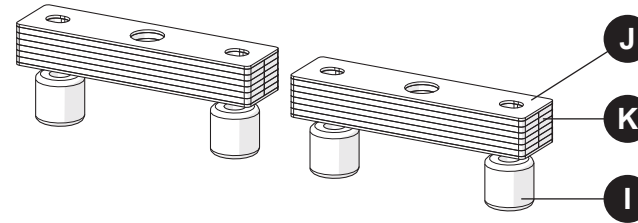

| KIT # 6 | DESCRIPTION | QTY |
|---------|-------------------------------|-----|
| J | AS2119-B01 Top plate | 4 |
| K | AS2119-B02 Foam cushion | 12 |
| I | GM59-B18 Rubber bumper (49mm) | 4 |

| PARTS | QTY | | |
|-------------------|-----|----|---|
| | J | K | I |
| VS-VFT + VS-FTS18 | 4 | 12 | 4 |
| VS-VFT + VS-FTS30 | 4 | 12 | 4 |

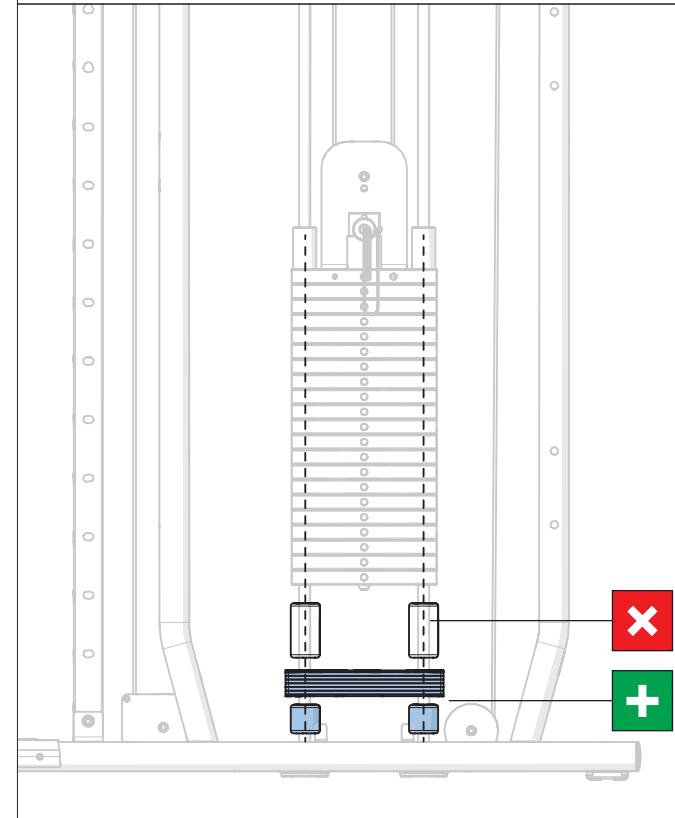
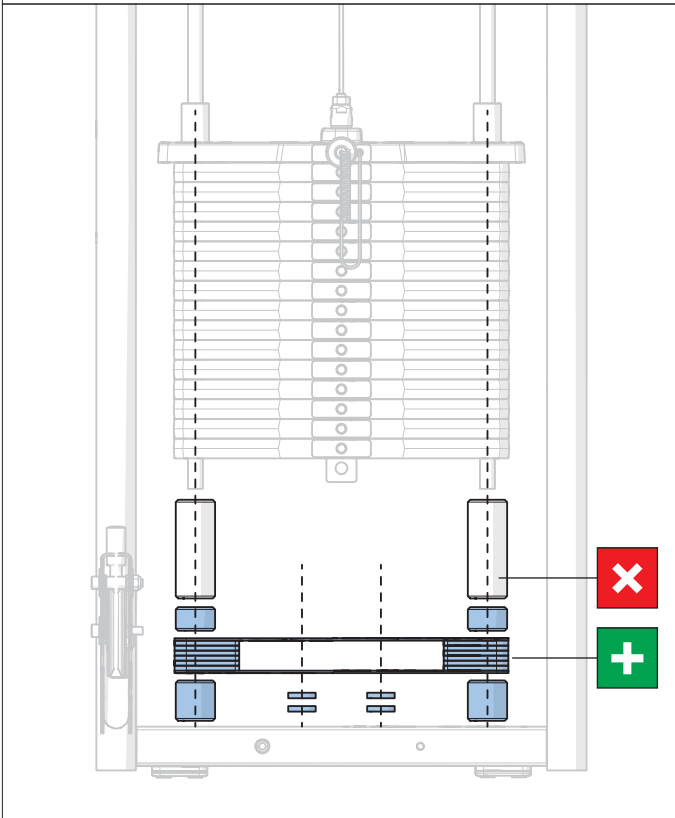

Remove 73.7mm bumpers.



KIT 7

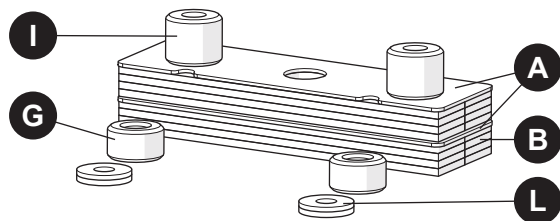

| KIT # 7 | DESCRIPTION | QTY |
|---------|---------------------------------|-----|
| A | AS2112-B01 Top plate | 2 |
| B | AS2108-B02 Foam cushion | 8 |
| G | GM77-Q05 Rubber bumper (30mm) | 2 |
| I | GM59-B18 Rubber bumper (49mm) | 2 |
| L | WASHER Flat washer (20x60L 2mm) | 4 |

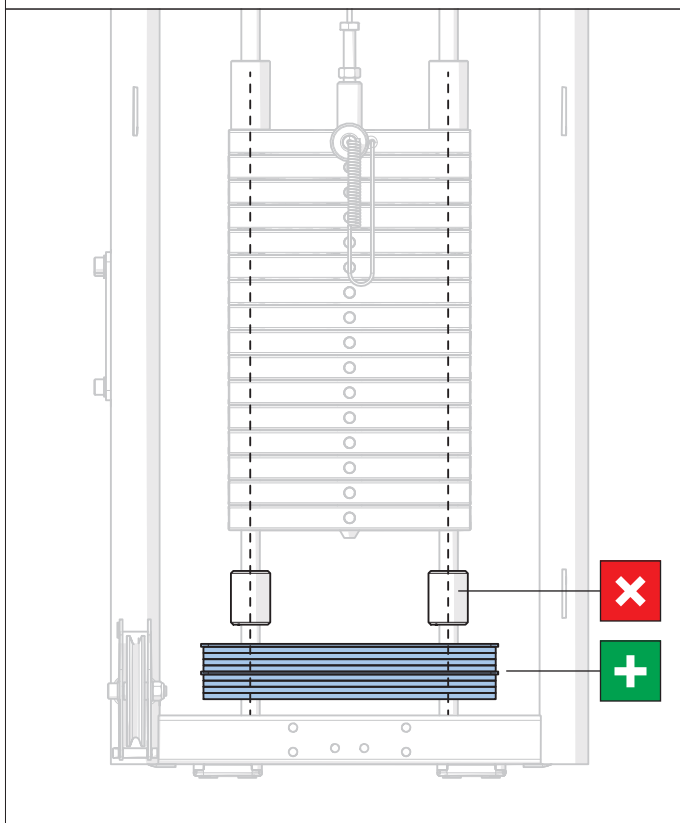

| PARTS | QTY | | | | | ORIGINAL BUMPER HEIGHT (remove) |
|--------|-----|---|---|---|---|---------------------------------|
| | A | B | G | I | L | |
| GO-S13 | 2 | 8 | 0 | 0 | 4 | 49mm |
| GO-S23 | 2 | 8 | 0 | 0 | 0 | 49mm |
| GO-S33 | 2 | 8 | 2 | 0 | 4 | 73.7mm |
| GO-S34 | 2 | 8 | 0 | 0 | 4 | 49mm |
| GO-S40 | 2 | 8 | 0 | 0 | 0 | 49mm |
| GO-S42 | 2 | 8 | 0 | 0 | 4 | 49mm |
| GO-S53 | 2 | 8 | 0 | 2 | 4 | 98.7mm |
| GO-S70 | 2 | 8 | 0 | 0 | 4 | 49mm |
| GO-S71 | 2 | 8 | 0 | 0 | 4 | 49mm |
| GO-S72 | 2 | 8 | 0 | 0 | 0 | 49mm |
| MD-AP* | 2 | 8 | 0 | 2 | 4 | 98.7mm |

GO-S33

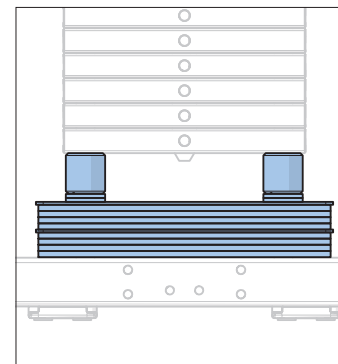

GO-S53

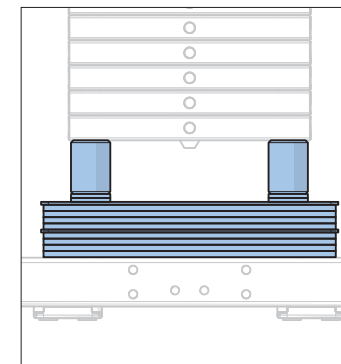

GO-S13 GO-S70
GO-S34 GO-S71
GO-S42

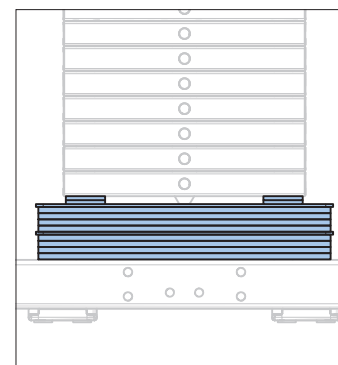

MD-AP

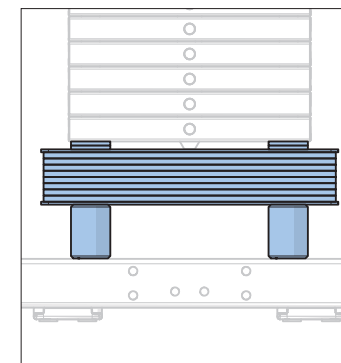



KIT 8

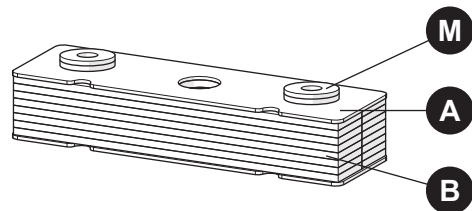

| KIT # 8 | DESCRIPTION | QTY |
|---------|--------------------------|-----|
| A | AS2112-B01 Top plate | 2 |
| B | AS2108-B02 Foam cushion | 8 |
| M | WASHER Flat washer (3mm) | 4 |

NOTE: Two semicircular holes should face inward, away from the screw heads on the frame.

| PARTS | A | B | M |
|----------|---|---|---|
| G7-S33 | 2 | 8 | 4 |
| G7-S70 | 2 | 8 | 2 |
| G7-S42 | 2 | 8 | 0 |
| G7-S79 | 2 | 8 | 2 |
| G7-S33BH | 2 | 8 | 4 |
| G7-S70BH | 2 | 8 | 2 |
| G7-S42BH | 2 | 8 | 0 |
| G7-S79BH | 2 | 8 | 2 |

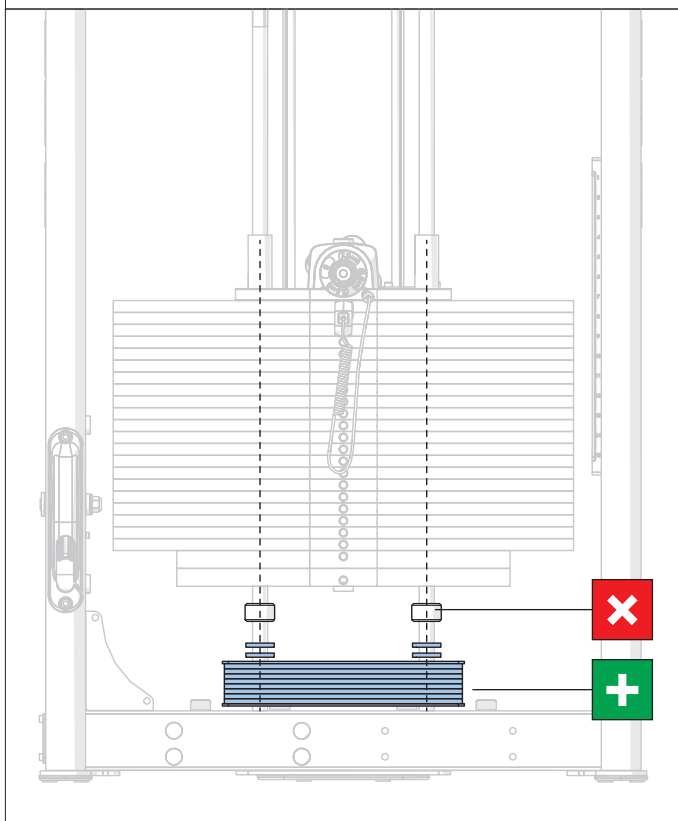

Remove 30mm bumpers.

Use washers if needed.

KIT 9

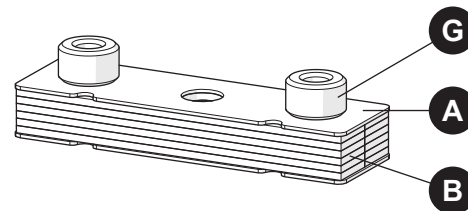

| KIT # 9 | DESCRIPTION | QTY |
|---------|-------------------------------|-----|
| A | AS2112-B01 Top plate | 2 |
| B | AS2108-B02 Foam cushion | 6 |
| G | GM77-Q05 Rubber bumper (30mm) | 2 |

NOTE: Two semicircular holes should face inward, away from the screw heads on the frame.

| PARTS | A | B | G |
|----------|---|---|---|
| G7-S78 | 2 | 6 | 2 |
| G7-S78BH | 2 | 6 | 2 |
| G7-S33B | 2 | 6 | 2 |
| G7-S34B | 2 | 6 | 2 |
| G7-S71B | 2 | 6 | 2 |
| G7-S70B | 2 | 6 | 2 |
| G7-S23B* | 2 | 6 | 2 |
| G7-S13B | 2 | 6 | 2 |
| G7-S42B | 2 | 6 | 2 |
| G7-S51B | 2 | 6 | 2 |
| G7-S22B | 2 | 6 | 2 |
| G7-S52B | 2 | 6 | 2 |
| G7-S78B* | 2 | 6 | 2 |
| G7-S21B* | 2 | 6 | 2 |
| G7-S79B | 2 | 6 | 2 |

* If cable adjustment won't align to the correct height, remove one foam insert.

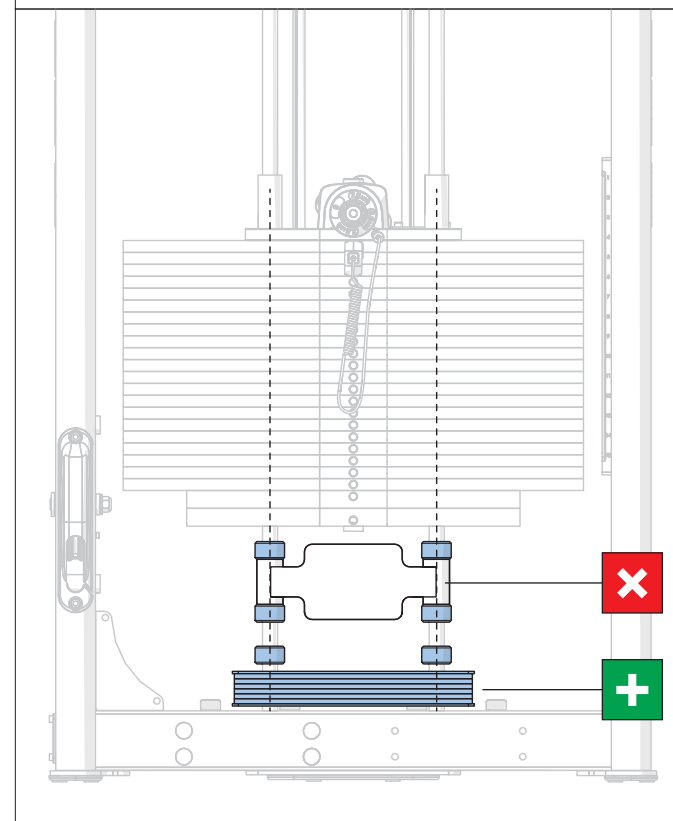

Remove guard.
Keep 4 bumpers.



KIT 10

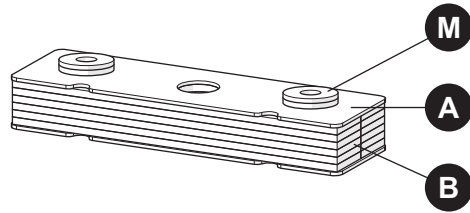

| KIT # 10 | DESCRIPTION | QTY |
|----------|--------------------------|-----|
| A | AS2112-B01 Top plate | 2 |
| B | AS2108-B02 Foam cushion | 6 |
| M | WASHER Flat washer (3mm) | 4 |

NOTE: Two semicircular holes should face inward, away from the screw heads on the frame.

- G7-S75
- G7-S74
- G7-S75BH
- G7-S74BH
- G7-S75B
- G7-S74B

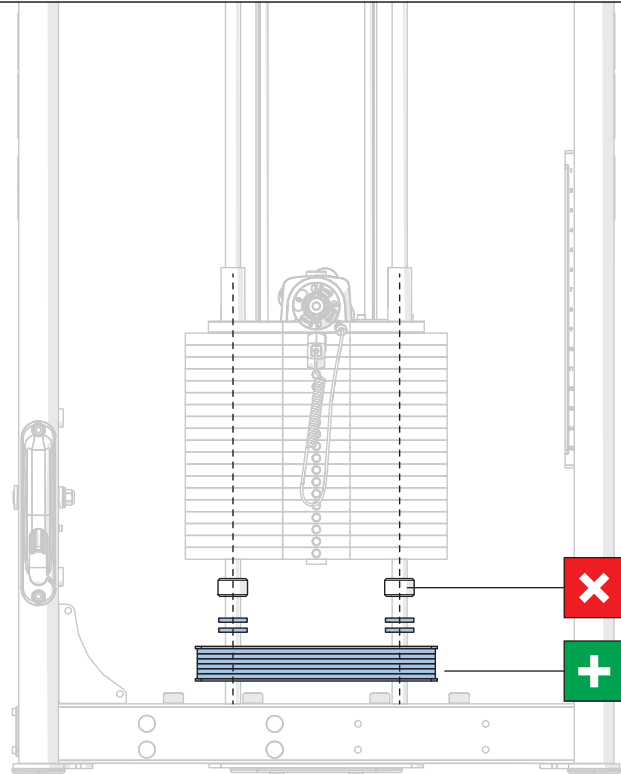
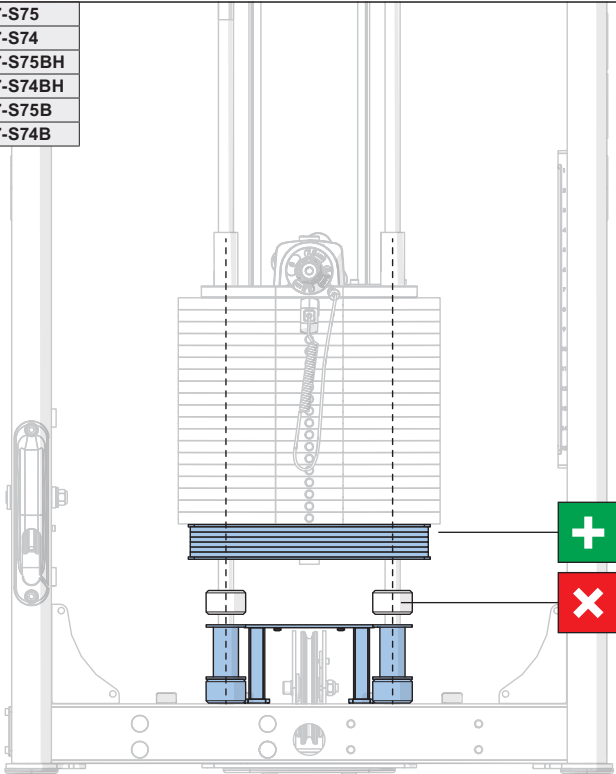

Remove top bumpers.

Use washers if needed.

| PARTS | QTY | | |
|----------|-----|---|---|
| | A | B | M |
| G7-S34 | 2 | 6 | 4 |
| G7-S71 | 2 | 6 | 4 |
| G7-S75 | 2 | 6 | 0 |
| G7-S77 | 2 | 6 | 0 |
| G7-S23 | 2 | 6 | 0 |
| G7-S13 | 2 | 6 | 4 |
| G7-S72 | 2 | 6 | 2 |
| G7-S74 | 2 | 6 | 0 |
| G7-S55 | 2 | 6 | 0 |
| G7-S40 | 2 | 6 | 0 |
| G7-S51 | 2 | 6 | 2 |
| G7-S22 | 2 | 6 | 4 |
| G7-S52 | 2 | 6 | 4 |
| G7-S73 | 2 | 6 | 2 |
| G7-S21 | 2 | 6 | 0 |
| G7-S41 | 2 | 6 | 0 |
| G7-S45 | 2 | 6 | 0 |
| G7-S34BH | 2 | 6 | 4 |
| G7-S71BH | 2 | 6 | 4 |
| G7-S75BH | 2 | 6 | 0 |
| G7-S77BH | 2 | 6 | 0 |
| G7-S23BH | 2 | 6 | 0 |
| G7-S13BH | 2 | 6 | 4 |
| G7-S72BH | 2 | 6 | 2 |
| G7-S74BH | 2 | 6 | 0 |
| G7-S55BH | 2 | 6 | 0 |
| G7-S40BH | 2 | 6 | 0 |
| G7-S51BH | 2 | 6 | 2 |
| G7-S22BH | 2 | 6 | 4 |
| G7-S52BH | 2 | 6 | 4 |
| G7-S73BH | 2 | 6 | 2 |
| G7-S21BH | 2 | 6 | 0 |
| G7-S41BH | 2 | 6 | 0 |
| G7-S45BH | 2 | 6 | 0 |
| G7-S75B* | 2 | 6 | 0 |
| G7-S77B* | 2 | 6 | 0 |
| G7-S72B | 2 | 6 | 0 |
| G7-S74B* | 2 | 6 | 0 |
| G7-S55B* | 2 | 6 | 0 |
| G7-S40B* | 2 | 6 | 0 |
| G7-S73B | 2 | 6 | 0 |
| G7-S41B* | 2 | 6 | 0 |
| G7-S45B* | 2 | 6 | 0 |

* If cable adjustment won't align to the correct height, remove one foam insert.



ADDITIONAL ASSEMBLY NOTES - KITS 8-10

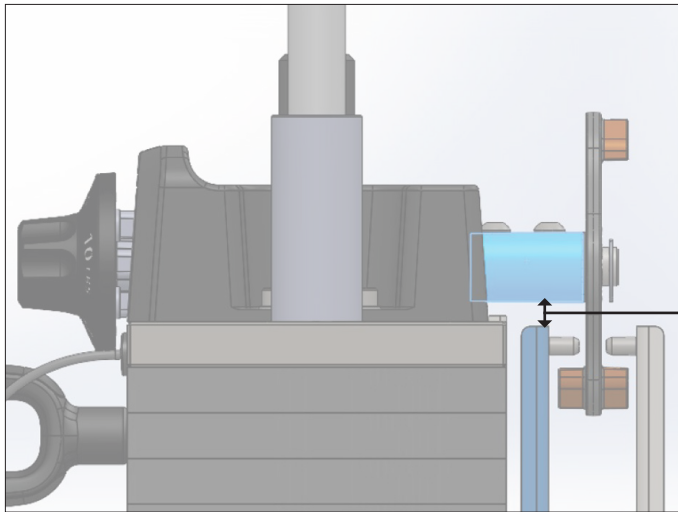

4 – 12 mm GAP

For Ultra units, the magnetic **INCREMENTAL WEIGHT** is space sensitive, so during install, please verify gaps are within tolerance:

- GAP 1: 4 – 12 mm
- GAP 2: 2 – 12 mm
- GAP 3: 0 mm, head plate should be flat

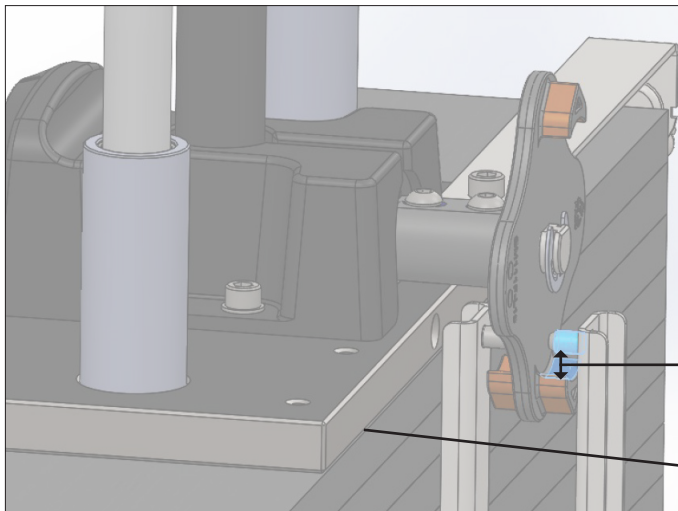

2 – 12 mm GAP

0 mm GAP

MATRIX



VRS KITS

© 2024 Johnson Health Tech

Rev 1.3 A